

### Features :

- Universal AC input active PFC
- Protections: Short circuit / Over load / Over voltage / Over Temp.
- All using 105°C long life electrolytic capacitors
- High operation temperature up to 65°C
- Active AC surge current limiting
- Power OK signal
- U-bracket low profile: 38mm
- Free air convection for 300W and 350W with 10.5CFM forced air
- DC fan supply is provided
- High power density 6.4w/in<sup>3</sup>
- Remoter Voltage sense
- 2 modes Remoter ON/OFF Ctrl. Setup by user
- Withstand 2G vibration test
- High efficiency, long life and high reliability
- 3 years warranty



MODEL		UP-350-12	UP-350-15	UP-350-24	UP-350-48
Output	DC Voltage Range	12V	15V	24V	48V
	Rated Current	29.2A	23.4A	14.6A	7.3A
	Current Range (convection)	0 ~ 25A	0 ~ 20A	0 ~ 12.5A	0 ~ 6.25A
	Rated Power (10.5CFM FAN)	0 ~ 29.2A	0 ~ 23.4A	0 ~ 14.6A	0 ~ 7.3A
	Rated Power (convection)	300W	300W	300W	300W
	Rated Power (10.5CFM FAN)	350.4W	351W	350.4W	350.4W
	Ripple & Noise (max.) <small>Note.2</small>	150 mVp-p	150 mVp-p	150 mVp-p	150 mVp-p
	Voltage Adj. Range	10.8 ~ 13.2V	13.5 ~ 16.5V	21.6 ~ 26.4V	43.2 ~ 52.8V
	Voltage Tolerance <small>Note.3</small>	±2%	±2%	±2%	±2%
	Line Regulation	±1%	±1%	±1%	±1%
	Load Regulation	±2%	±2%	±2%	±2%
	Setup, Rise Time	550ms, 30ms at full load			
Hold Up Time (Typ.)	16ms / 230VAC at full load				
Input	Voltage Range <small>Note.4</small>	90 ~ 264VAC	127 ~ 370VDC		
	Frequency Range	47 ~ 63Hz			
	Efficiency (Typ.)	88%	89%	89%	90%
	AC Current (Typ.)	4 A / 115VAC	2A / 230VAC		
	Inrush Current (Typ.)	22A / 115VAC 44A / 230VAC			
	Leakage Current	< 2mA / 230VAC			
Protection	Over Load	> 105% rated output power Protection type : constant current limiting, output voltage less than 50% rating DC voltage range after 500ms the unit will shutdown			
	Over Voltage	115% ~ 150% rated output voltage Protection type : latch-off mode, re-power on to recover			
	Over Temperature	100°C ±5°C With N2, 100°C ±5°C With TH1 sense near D26 heat sink	100°C ±5°C With N2, 90°C ±5°C With TH1 sense near D26 heat sink		
Environment	Working Temp.	-20°C ~ +65°C (Refer to output load de-rating curve)			
	Working Humidity	20 ~ 90% RH non-condensing			
	Storage Temp., Humidity	-40 ~ +85°C 10 ~ 95% R.H			
	Temp.Coefficient	±0.03%/°C (0 ~ 50°C)			
	Vibration	10 ~ 500Hz, 2G 10min./1 cycle, period for 60 min. Each along X,Y,Z axes			
Safety & EMC <small>Note.5</small>	Safety Standards	UL 60950-1, 2 <sup>nd</sup> Edition, TUV EN60950-1 : 2006+A11 Approved			
	Withstand Voltage	I/P - O/P : 4242 DC I/P - FG : 2121 DC 1 minute			
	Isolation Resistance	I/P - O/P, I/P - FG, O/P - FG: 100M Ω / 500VDC			
	EMI Conduction & Radiation	EN55022: 2006 Class B			
	Harmonic Current	EN61000-3-2: 2006 Class A, EN61000-3-3: 1995+A1: 2001+A2: 2005			
	EMS Immunity	EN61204-3: 2000, EN55024:1998+A1: 2001+A2: 2003 light industry level, criteria A			
Others	Connection	I/P 5P / 3.96mm pitch, O/P : 6P/9.5mm terminal block with cover or 9Px2 3.96mm pitch(select by user)			
	Power OK signal	Open Darin			
	Cooling	Free Air convection for 300W, With 10.5CFM Fan for 350W			
	MTBF (MIL-HDBK-217F)	58.13K Hours			
	ON/OFF Remote Control	2 modes setup remote ON/OFF see Function Description of J2			
	Remote Voltage sense	Compensates for wire voltage drop			
	Dimension (W*H*D)(mm)	231x101.5x38			
	Packing	1.06kg ; 16Pcs/18kg			

### Note

1. All parameters NOT specially mentioned are measured at 230VAC input, rated load and 25°C of ambient temperature.
2. Ripple & noise are measured at 20MHz of bandwidth by using a 12" twisted pair-wire terminated with a 0.1uf & 47 uf parallel capacitor.
3. Tolerance: includes set up tolerance, line regulation and load regulation.
4. De-rating may be needed under low input voltages. Please check the de-rating curve for more details.
5. The power supply is considered a component which will be installed into a final equipment. The final equipment must be re-confirmed that it still meets EMC directives.

### Mechanical Specification

Unit : mm

#### MODEL:UP-350C

AC Input Connector (CN1) :

JST B5P-VH or equivalent

Pin. No.	Assignment	Mating Housing	Terminal
1	Ground/Earth	FG	JST VHR or equivalent
2	N.C	N.C	
3	Neutral	AC/N	
4	N.C	N.C	
5	Live	AC/L	

Connector pin number assignment (CN2) :

JST B8B-PHDSS or equivalent

Pin. No.	Assignment	Mating Housing	Terminal
1	VS+	JST PHD-08VS or equivalent	JST SPHD-002T-P05 or equivalent
2	S GND		
3	INH-		
4	NC		
5	VS-		
6	POK		
7	INH+		
8	VS-		

External FAN Power Connector(CN3):

Pin. No.	Assignment	Mating Housing	Terminal
1	SGND	JST XHP-2 or equivalent	JST SXH-001T-0.6 or equivalent
2	12V+		

DC Output Connector(CN5/CN6 for UP-350C):

JST B9P-VH\*2 or equivalent

Pin. No.	Assignment	Mating Housing	Terminal
1-9	VO-	JST VHR or equivalent	JST SVH-21T-P1.1 or equivalent
	Return		
10-18	VO+	+Main Output	

#### MODEL:UP-350T

AC Input Connector (CN1) :

JST B5P-VH or equivalent

Pin. No.	Assignment	Mating Housing	Terminal
1	Ground/Earth	FG	JST VHR or equivalent
2	N.C	N.C	
3	Neutral	AC/N	
4	N.C	N.C	
5	Live	AC/L	

Connector pin number assignment (CN2) :

JST B8B-PHDSS or equivalent

Pin. No.	Assignment	Mating Housing	Terminal
1	VS+	JST PHD-08VS or equivalent	JST SPHD-002T-P05 or equivalent
2	S GND		
3	INH-		
4	NC		
5	VS-		
6	POK		
7	INH+		
8	VS-		

External FAN Power Connector(CN3):

Pin. No.	Assignment	Mating Housing	Terminal
1	SGND	JST XHP-2 or equivalent	JST SXH-001T-0.6 or equivalent
2	12V+		

Remote Sense(CN4) Pitch 9.5mm :

Pin. No.	Assignment
1	VO(-) Return
2	VO(-) Return
3	VO(-) Return
4	VO(+)+Main Output
5	VO(+)+Main Output
6	VO(+)+Main Output

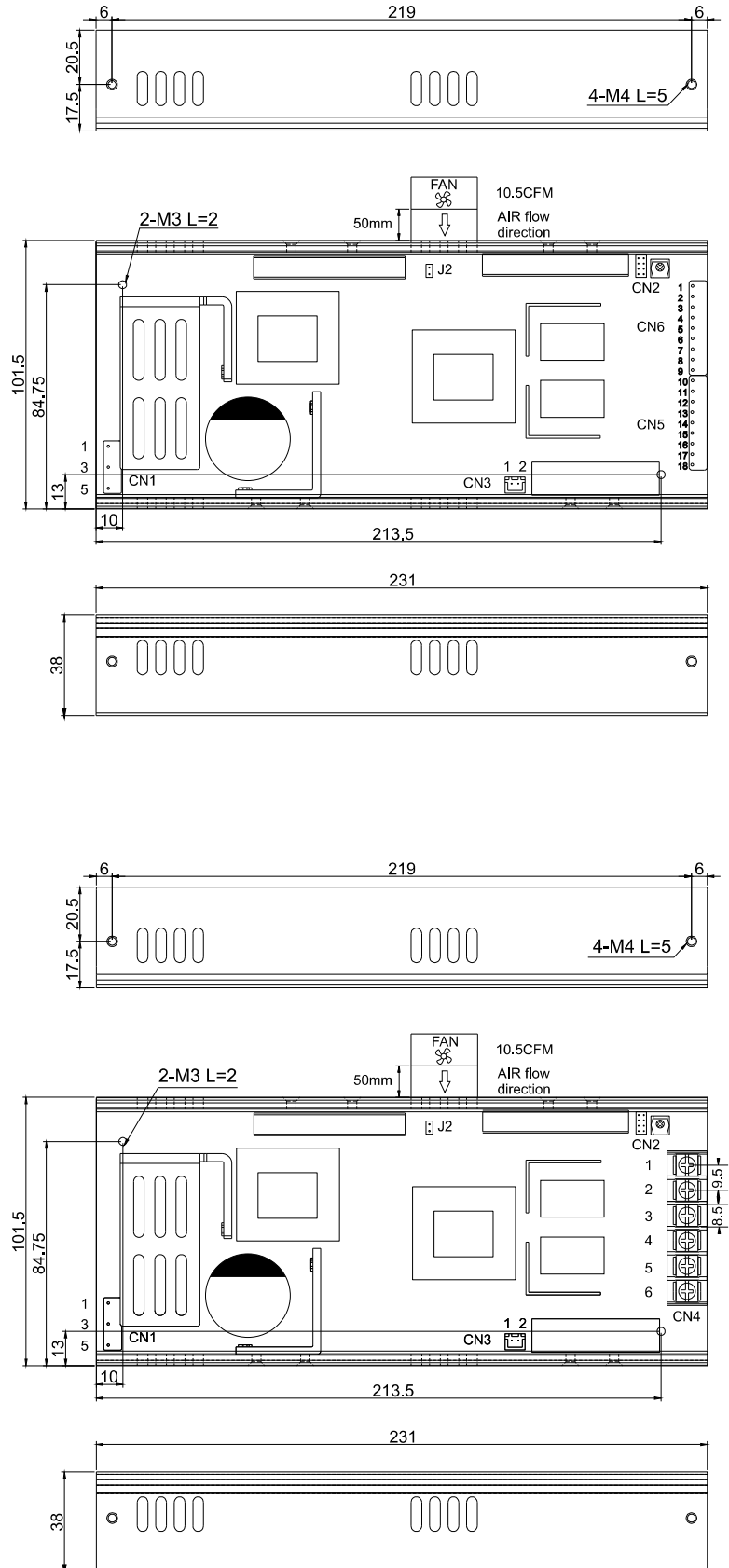

### Block Diagram

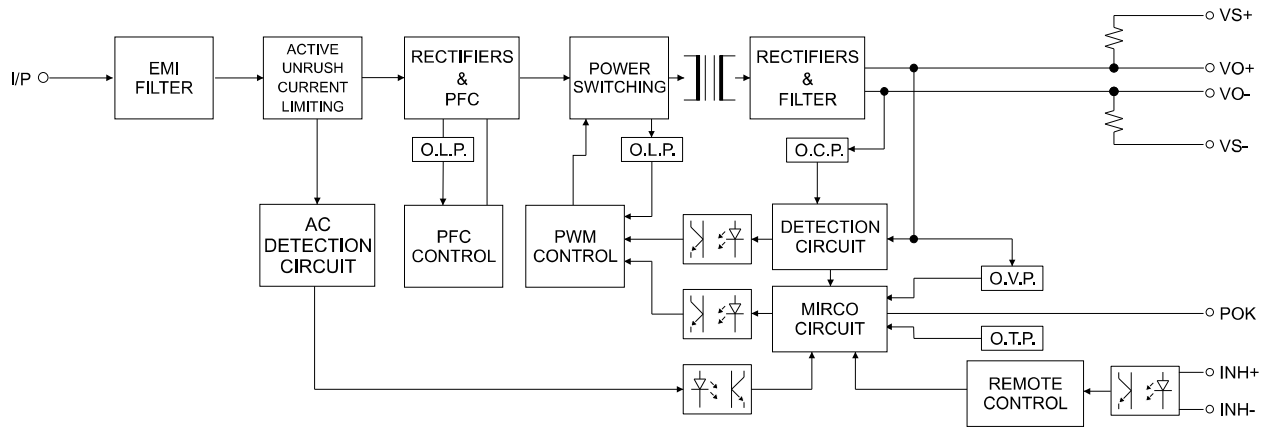

### De-rating Curve

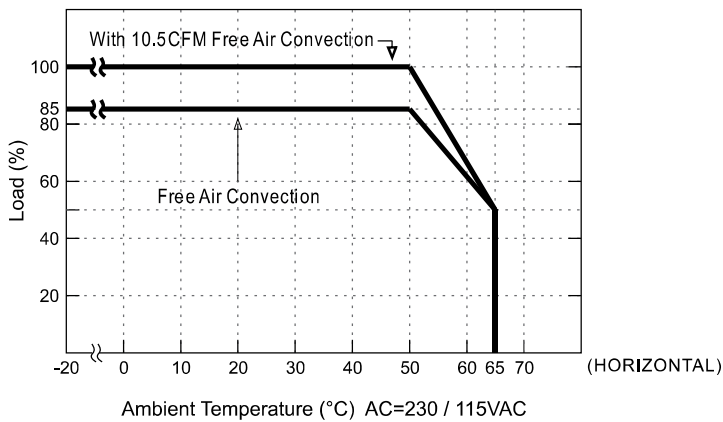

### Static Characteristics

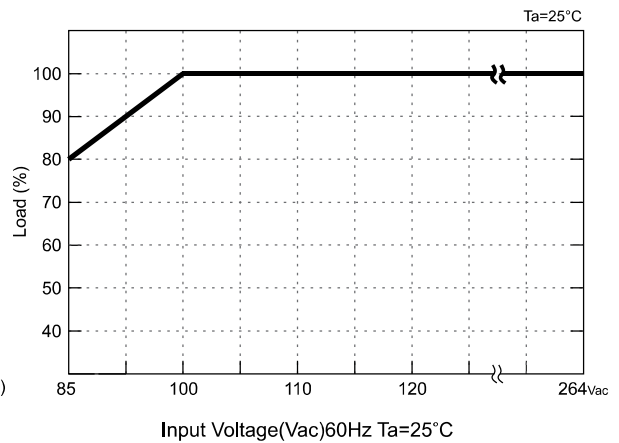

### Function Description of CN2, J2

#### 1. Remote Control

The PSU can be turned ON/OFF by using the "Remote Control" function.

J2 PIN & CN2 CONNECTIONS		
J2	INH+ (7 PIN)/ INH- (3 PIN)	Output Status
Open	SW ON (>2.5V)	ENABLE
Open	SW OFF (<0.8V)	DISABLE
Close	SW ON (>2.5V)	DISABLE
Close	SW OFF (<0.8V)	ENABLE

(Default Setting)

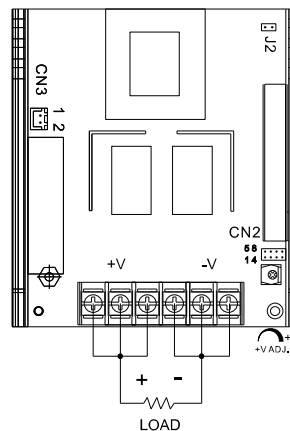
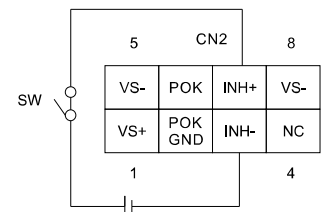

Fig 1.1



External Power Source I=6~20mA

### ■ Fuction Description of CN2, J2

#### 2.P-OK CONTROL

POK Signal use open drain mossfet contol  
MAX:30Vds,0.1A

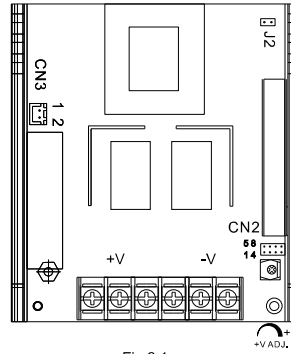
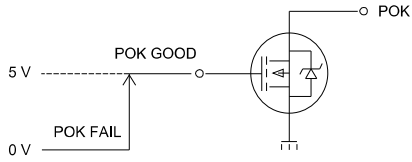
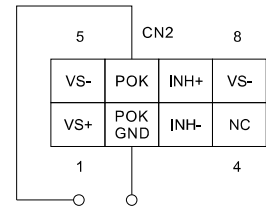
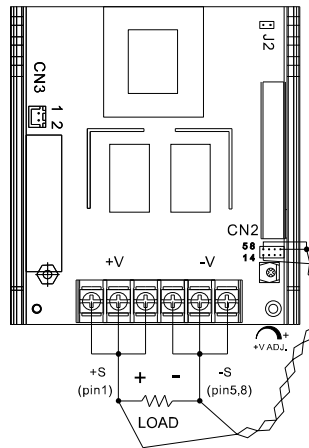

Fig 2.1



#### 3.Remote Sense

The remote sensing compensates voltage drop on the load wiring up to 0.5V.



Sense lines should be twisted in pairs

Fig 3.1

